

## Park Brow Community Primary School

Updated by P.Holden, 2022



**Park Brow  
Primary School**

Happy - Respect - Pride - Caring - Potential



### ***Power Maths White Rose Edition* calculation policy, KS1**

The following pages show the *Power Maths White Rose Edition* progression in calculation (addition, subtraction, multiplication and division) and how this works in line with the National Curriculum. The consistent use of the CPA (concrete, pictorial, abstract) approach across *Power Maths White Rose Edition* helps children develop mastery across all the operations in an efficient and reliable way. This policy shows how these methods develop children's confidence in their understanding of both written and mental methods.

## KEY STAGE 1

Children develop the core ideas that underpin all calculation. They begin by connecting calculation with counting on and counting back, but they should learn that understanding wholes and parts will enable them to calculate efficiently and accurately, and with greater flexibility. They learn how to use an understanding of 10s and 1s to develop their calculation strategies, especially in addition and subtraction.

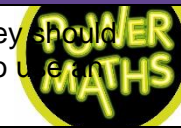

**Key language:** whole, part, ones, ten, tens, number bond, add, addition, plus, total, altogether, subtract, subtraction, find the difference, take away, minus, less, more, group, share, equal, equals, is equal to, groups, equal groups, times, multiply, multiplied by, divide, share, shared equally, times-table

**Addition and subtraction:** Children first learn to connect addition and subtraction with counting, but they soon develop two very important skills: an understanding of parts and wholes, and an understanding of unitising 10s, to develop efficient and effective calculation strategies based on known number bonds and an increasing awareness of place value. Addition and subtraction are taught in a way that is interlinked to highlight the link between the two operations. A key idea is that children will select methods and approaches based on their number sense. For example, in Year 1, when faced with  $15 - 3$  and  $15 - 13$ , they will adapt their ways of approaching the calculation appropriately. The teaching should always emphasise the importance of mathematical thinking to ensure accuracy and flexibility of approach, and the importance of using known number facts to harness their recall of bonds within 20 to support both addition and subtraction methods.

**Multiplication and division:** Children develop an awareness of equal groups and link this with counting in equal steps, starting with 2s, 5s and 10s. In Year 2, they learn to connect the language of equal groups with the mathematical symbols for multiplication and division.



They learn how multiplication and division can be related to repeated addition and repeated subtraction to find the answer to the calculation. In this key stage, it is vital that children explore and experience a variety of strong images and manipulative representations of equal groups, including concrete experiences as well as abstract calculations.





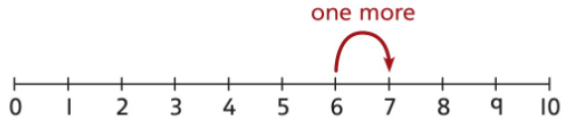
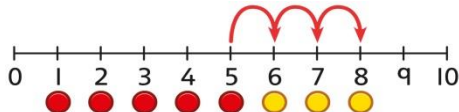

Children begin to recall some key multiplication facts, including doubles, and an understanding of the 2, 5 and 10 times-tables and how they are related to counting.

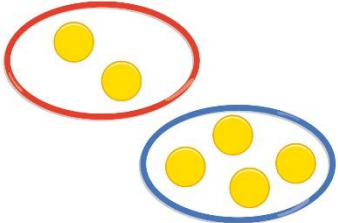
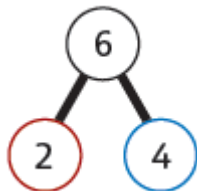
**Fractions:** In Year 1, children encounter halves and quarters, and link this with their understanding of sharing. They experience key spatial representations of these fractions, and learn to recognise examples and non-examples, based on their awareness of equal parts of a whole.

In Year 2, they develop an awareness of unit fractions and experience non-unit fractions, and they learn to write them and read them in the common format of numerator and denominator.

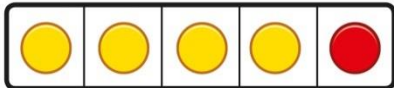
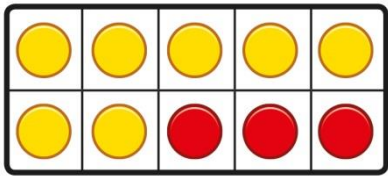
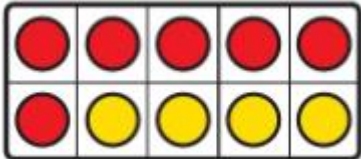
## Year 1

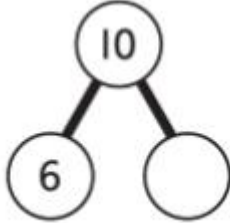
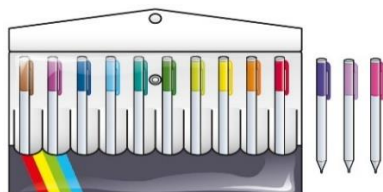
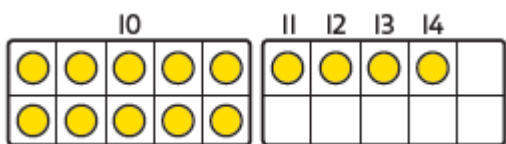
	Concrete	Pictorial	Abstract
<b>Year 1 Addition</b>			
<b>Counting and adding more</b>	<p>Children add one more person or object to a group to find one more.</p>	<p>Children add one more cube or counter to a group to represent one more.</p>  <p><i>One more than 4 is 5.</i></p>	<p>Use a number line to understand how to link counting on with finding one more.</p>  <p><i>One more than 6 is 7. 7 is one more than 6.</i></p> <p>Learn to link counting on with adding more than one.</p>  <p><math>5 + 3 = 8</math></p>
<b>Understanding part-part-whole relationship</b>	<p>Sort people and objects into parts and understand the relationship with the whole.</p>  <p><i>The parts are 2 and 4. The whole is 6.</i></p>	<p>Children draw to represent the parts and understand the relationship with the whole.</p>  <p><i>The parts are 2 and 4. The whole is 6.</i></p>	<p>Use a part-whole model to represent the numbers.</p>  <p><math>2 + 4 = 6</math></p>
<b>Knowing and finding number bonds within 10</b>	<p>Break apart a group and put back together to find and form number bonds.</p>	<p>Use five and ten frames to represent key number bonds.</p>	<p>Use a part-whole model alongside other representations to find number bonds.</p>

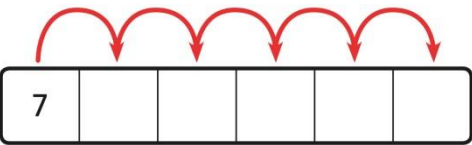
	 <p><math>3 + 4 = 7</math></p>  <p><math>6 = 2 + 4</math></p>	 <p><math>5 = 4 + 1</math></p>  <p><math>10 = 7 + 3</math></p>	   <p>Make sure to include examples where one of the parts is zero.</p>
<p><b>Understanding teen numbers as a complete 10 and some more</b></p>	<p>Complete a group of 10 objects and count more.</p>  <p><i>13 is 10 and 3 more.</i></p>	<p>Use a ten frame to support understanding of a complete 10 for teen numbers.</p>  <p><i>14 is 10 and 4 more.</i></p>	<p><i>1 ten and 5 ones equal 15.</i> <math>10 + 5 = 15</math></p>
<p><b>Adding by counting on</b></p>	<p>Children use knowledge of counting to 20 to find a total by counting on using people or objects.</p>	<p>Children use counters to support and represent their counting on strategy.</p>  	<p>Children use number lines or number tracks to support their counting on strategy.</p>  <p><math>7 + 5 = \square</math></p>

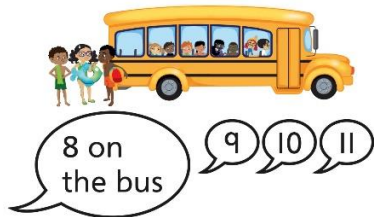

**Year 1 Subtraction**

**Counting back and taking away**

Children arrange objects and remove to find how many are left.



1 less than 6 is 5.  
6 subtract 1 is 5.

Children draw and cross out or use counters to represent objects from a problem.



Now there are 6 children.

Children count back to take away and use a number line or number track to support the method.

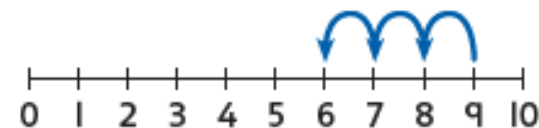

$$9 - 3 = 6$$

**Finding a missing part, given a whole and a part**

Children separate a whole into parts and understand how one part can be found by subtraction.

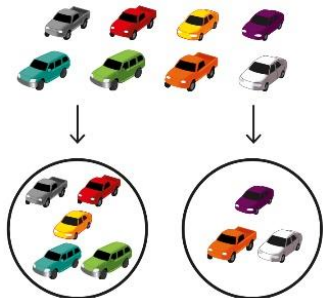

$$8 - 5 = ?$$

Children represent a whole and a part and understand how to find the missing part by subtraction.





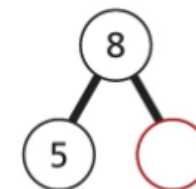





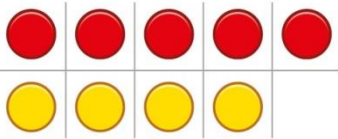

Children use a part-whole model to support the subtraction to find a missing part.



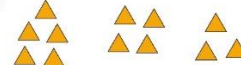

$$8 - 5 = ?$$

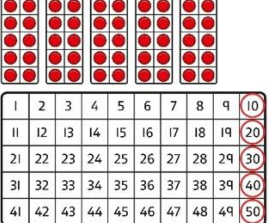
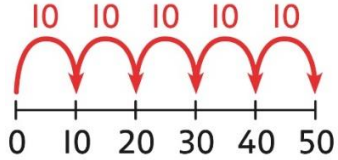
Children develop an understanding of the relationship between addition and subtraction facts in a part-whole model.

			
<p><b>Finding the difference</b></p>	<p>Arrange two groups so that the difference between the groups can be worked out.</p>  <p>8 is 2 more than 6. 6 is 2 less than 8. The difference between 8 and 6 is 2.</p>	<p>Represent objects using sketches or counters to support finding the difference.</p>  <p><math>5 - 4 = 1</math> The difference between 5 and 4 is 1.</p>	<p>Children understand 'find the difference' as subtraction.</p>  <p><math>10 - 4 = 6</math> The difference between 10 and 6 is 4.</p>
<p><b>Year 1 Multiplication</b></p>			
<p><b>Recognising and making equal groups</b></p>	<p>Children arrange objects in equal and unequal groups and understand how to recognise whether they are equal.</p> <p>A  B  C </p>	<p>Children draw and represent equal and unequal groups.</p> <p>A  B </p>	<p>Three equal groups of 4. Four equal groups of 3.</p>
<p><b>Finding the total of equal groups by counting in 2s, 5s and 10s</b></p>	 <p>There are 5 pens in each pack ... 5...10...15...20...25...30...35...40...</p>	<p>100 squares and ten frames support counting in 2s, 5s and 10s.</p> 	<p>Use a number line to support repeated addition through counting in 2s, 5s and 10s.</p> 
<p><b>Year 1</b></p>			

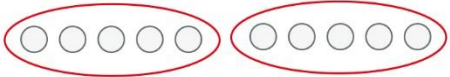
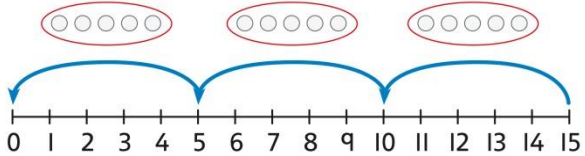
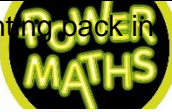
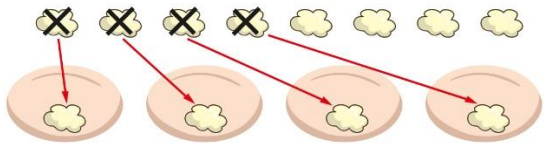





Division			
<p><b>Grouping</b></p>	<p>Learn to make equal groups from a whole and find how many equal groups of a certain size can be made.</p> <p>Sort a whole set people and objects into equal groups.</p>  <p><i>There are 10 children altogether. There are 2 in each group. There are 5 groups.</i></p>	<p>Represent a whole and work out how many equal groups.</p>  <p><i>There are 10 in total. There are 5 in each group. There are 2 groups.</i></p>	<p>Children may relate this to counting back in steps of 2, 5 or 10.</p>  
<p><b>Sharing</b></p>	<p>Share a set of objects into equal parts and work out how many are in each part.</p> 	<p>Sketch or draw to represent sharing into equal parts. This may be related to fractions.</p> 	<p><i>10 shared into 2 equal groups gives 5 in each group.</i></p>

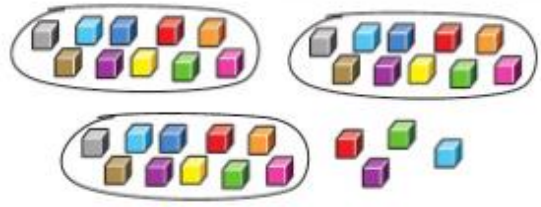
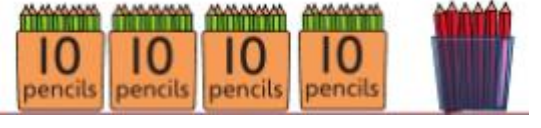
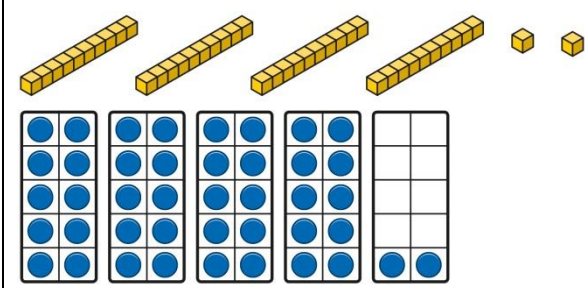
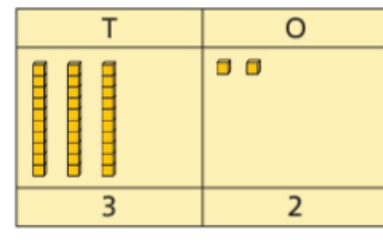
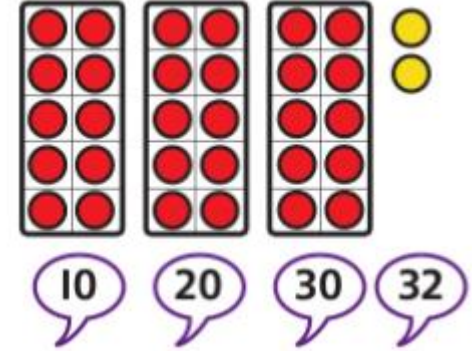
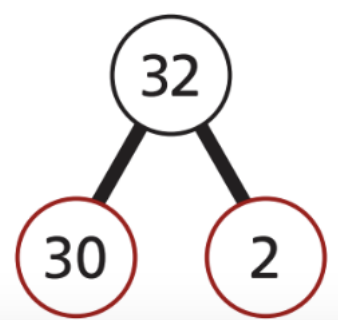

Year 2

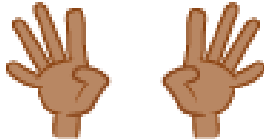
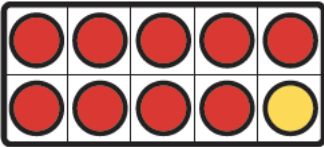

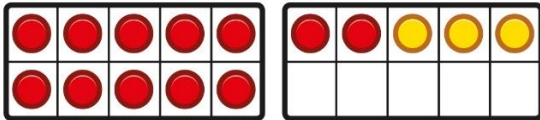
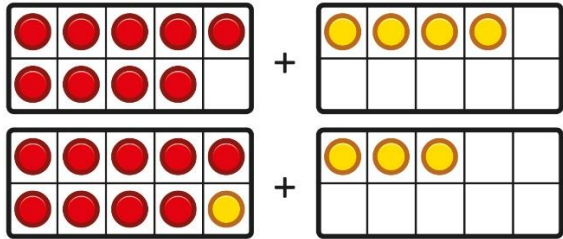
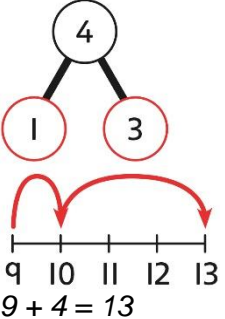
	Concrete	Pictorial	Abstract
<b>Year 2 Addition</b>			
<b>Understanding 10s and 1s</b>	<p>Group objects into 10s and 1s.</p>  <p>Bundle straws, pencils or pens to understand unitising of 10s.</p> 	<p>Understand 10s and 1s equipment, and link with visual representations on ten frames.</p>  <p>Represent numbers on a place value grid, using equipment or numerals.</p> 	<p>Partition 2-digit numbers into 10s and 1s</p>   <p><math>32 = 30 + 2</math></p>
<b>Learn bonds within 10</b>	Systematically build confidence and fluency in recall of number bonds within 10	Systematically build confidence and fluency in recall of number bonds within 10	Systematically build confidence and fluency in recall of number bonds within 10

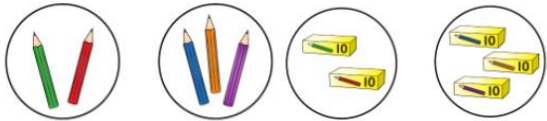
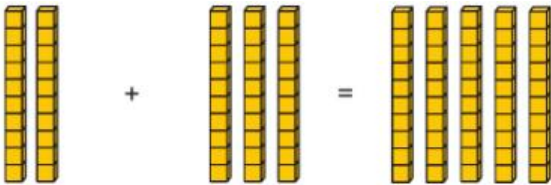

	<p>Double 4</p>   <p><math>4 + 4 = 8</math>. This is a double</p>	<p>This is a bond to 10. <math>9 + 1 = 10</math></p>	<table border="1"> <thead> <tr> <th>+</th> <th>0</th> <th>1</th> <th>2</th> <th>3</th> <th>4</th> <th>5</th> <th>6</th> <th>7</th> <th>8</th> <th>9</th> <th>10</th> </tr> </thead> <tbody> <tr> <th>0</th> <td>0+0</td> <td>0+1</td> <td>0+2</td> <td>0+3</td> <td>0+4</td> <td>0+5</td> <td>0+6</td> <td>0+7</td> <td>0+8</td> <td>0+9</td> <td>0+10</td> </tr> <tr> <th>1</th> <td>1+0</td> <td>1+1</td> <td>1+2</td> <td>1+3</td> <td>1+4</td> <td>1+5</td> <td>1+6</td> <td>1+7</td> <td>1+8</td> <td>1+9</td> <td></td> </tr> <tr> <th>2</th> <td>2+0</td> <td>2+1</td> <td>2+2</td> <td>2+3</td> <td>2+4</td> <td>2+5</td> <td>2+6</td> <td>2+7</td> <td>2+8</td> <td></td> <td></td> </tr> <tr> <th>3</th> <td>3+0</td> <td>3+1</td> <td>3+2</td> <td>3+3</td> <td>3+4</td> <td>3+5</td> <td>3+6</td> <td>3+7</td> <td></td> <td></td> <td></td> </tr> <tr> <th>4</th> <td>4+0</td> <td>4+1</td> <td>4+2</td> <td>4+3</td> <td>4+4</td> <td>4+5</td> <td>4+6</td> <td></td> <td></td> <td></td> <td></td> </tr> <tr> <th>5</th> <td>5+0</td> <td>5+1</td> <td>5+2</td> <td>5+3</td> <td>5+4</td> <td>5+5</td> <td></td> <td></td> <td></td> <td></td> <td></td> </tr> <tr> <th>6</th> <td>6+0</td> <td>6+1</td> <td>6+2</td> <td>6+3</td> <td>6+4</td> <td></td> <td></td> <td></td> <td></td> <td></td> <td></td> </tr> <tr> <th>7</th> <td>7+0</td> <td>7+1</td> <td>7+2</td> <td>7+3</td> <td></td> <td></td> <td></td> <td></td> <td></td> <td></td> <td></td> </tr> <tr> <th>8</th> <td>8+0</td> <td>8+1</td> <td>8+2</td> <td></td> <td></td> <td></td> <td></td> <td></td> <td></td> <td></td> <td></td> </tr> <tr> <th>9</th> <td>9+0</td> <td>9+1</td> <td></td> <td></td> <td></td> <td></td> <td></td> <td></td> <td></td> <td></td> <td></td> </tr> <tr> <th>10</th> <td>10+0</td> <td></td> <td></td> <td></td> <td></td> <td></td> <td></td> <td></td> <td></td> <td></td> <td></td> </tr> </tbody> </table>	+	0	1	2	3	4	5	6	7	8	9	10	0	0+0	0+1	0+2	0+3	0+4	0+5	0+6	0+7	0+8	0+9	0+10	1	1+0	1+1	1+2	1+3	1+4	1+5	1+6	1+7	1+8	1+9		2	2+0	2+1	2+2	2+3	2+4	2+5	2+6	2+7	2+8			3	3+0	3+1	3+2	3+3	3+4	3+5	3+6	3+7				4	4+0	4+1	4+2	4+3	4+4	4+5	4+6					5	5+0	5+1	5+2	5+3	5+4	5+5						6	6+0	6+1	6+2	6+3	6+4							7	7+0	7+1	7+2	7+3								8	8+0	8+1	8+2									9	9+0	9+1										10	10+0										
+	0	1	2	3	4	5	6	7	8	9	10																																																																																																																																								
0	0+0	0+1	0+2	0+3	0+4	0+5	0+6	0+7	0+8	0+9	0+10																																																																																																																																								
1	1+0	1+1	1+2	1+3	1+4	1+5	1+6	1+7	1+8	1+9																																																																																																																																									
2	2+0	2+1	2+2	2+3	2+4	2+5	2+6	2+7	2+8																																																																																																																																										
3	3+0	3+1	3+2	3+3	3+4	3+5	3+6	3+7																																																																																																																																											
4	4+0	4+1	4+2	4+3	4+4	4+5	4+6																																																																																																																																												
5	5+0	5+1	5+2	5+3	5+4	5+5																																																																																																																																													
6	6+0	6+1	6+2	6+3	6+4																																																																																																																																														
7	7+0	7+1	7+2	7+3																																																																																																																																															
8	8+0	8+1	8+2																																																																																																																																																
9	9+0	9+1																																																																																																																																																	
10	10+0																																																																																																																																																		
<p><b>Adding the 1s</b></p>	<p>Children represent 10s and 1s with everyday items.</p> 	<p>Children represent calculations using ten frames to add a teen and 1s.</p>  <p><math>2 + 3 = 5</math> <math>12 + 3 = 15</math></p>	<p>Children recognise that a teen is made from a 10 and some 1s and use their knowledge of addition within 10 to work efficiently.</p> <p><math>3 + 5 = 8</math> So, <math>13 + 5 = 18</math></p>																																																																																																																																																
<p><b>Bridging 10 using number bonds</b></p>	<p>Children use counters to complete a ten frame and understand how they can add using knowledge of number bonds to 10.</p> 	<p>Use a part-whole model and a number line to support the calculation.</p>  <p><math>9 + 4 = 13</math></p>	<p>Children use a bead string to complete a 10 and understand how this relates to the addition.</p>  <p>7 add 3 makes 10. So, 7 add 5 is 10 and 2 more.</p>																																																																																																																																																
<p><b>Add two multiples of 10</b></p>	<p>Use known bonds and unitising to add 10s.</p>	<p>Use known bonds and unitising to add 10s.</p> 	<p>Use known bonds and unitising to add 10s.</p>																																																																																																																																																

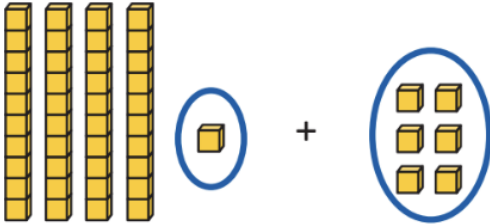
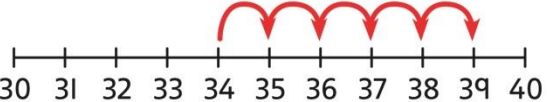

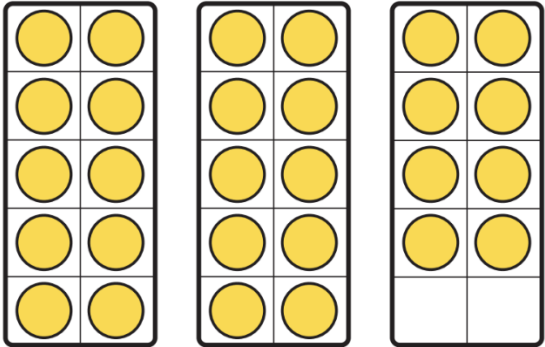
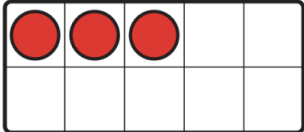
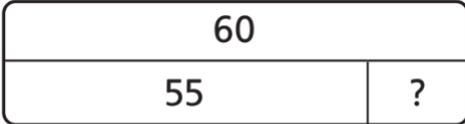
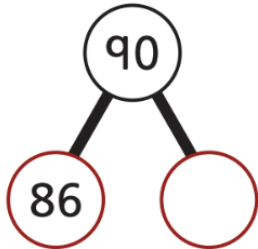
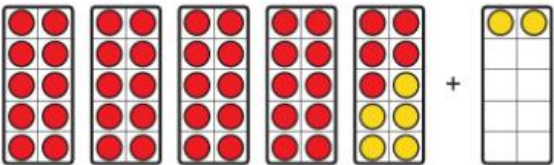
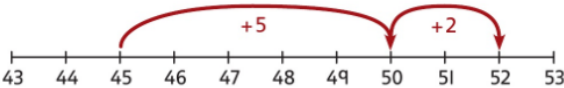
	 <p><i>I know that <math>2 + 3 = 5</math>.</i></p> <p><i>So, I know that 2 tens add 3 tens is 5 tens.</i></p>	 <p><i>I know that <math>2 + 3 = 5</math></i></p> <p><i>So, I know that 2 tens add 3 tens is 5 tens.</i></p>	 <p><math>3 + 2 = 5</math>  <math>3 \text{ tens} + 2 \text{ tens} = 5 \text{ tens}</math>  <math>30 + 20 = 50</math></p>
<p><b>Add a 2-digit number and 1s</b></p>	<p>Add the 1s to find the total. Use known bonds within 10.</p>  <p><i>41 is 4 tens and 1 one.</i></p> <p><i>41 add 6 ones is 4 tens and 7 ones.</i></p>	<p>Add the ones using known bonds</p>  <p><math>1 + 6 = 7</math></p> <p>So</p> <p><math>41 + 6 = 47</math></p>	<p>Add the 1s.</p> <p>Understand the link between counting on and using known number facts. Children should be encouraged to use known number bonds to improve efficiency and accuracy.</p>  <p><math>4 + 5 = 9</math></p> <p>So</p> <p><math>34 + 5 = 39</math></p>
<p><b>Add to the next 10</b></p>	<p>Use known bonds to 10 to add to the next multiple of 10</p>	<p>Use known bonds to 10 to add to the next multiple of 10</p>	<p>Use known bonds to 10 to add to the next multiple of 10</p>

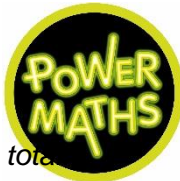
	 <p><math>8 + 2 = 10</math></p> <p>So</p> <p><math>28 + 2 = 30</math></p>	<p><math>3 + \square = 10</math></p> <p><math>33 + \square = 40</math></p> <p><math>43 + \square = 50</math></p> <p><math>73 + \square = 80</math></p> 	 <p><math>55 + \square = 60</math></p>  <p><math>86 + \square = 90</math></p>
<p><b>Add across a 10</b></p>	<p>Use place value equipment to support adding across any multiple of 10</p>  <p><math>45 + 5 + 2 = 52</math></p> <p><math>45 + 7 = 52</math></p>	<p>Add across any multiple of 10 using two jumps</p>  <p><math>45 + 5 + 2 = 52</math></p> <p><math>45 + 7 = 52</math></p>	<p>Add across any multiple of 10 using two steps</p> <p><math>45 + 5 + 2 = 52</math></p> <p><math>45 + 7 = 52</math></p>
<p><b>Add 10s to a 2-digit number</b></p>	<p>Add the 10s using a place value grid to support, using classroom items to represent the numbers.</p>	<p>Add the 10s using a place value grid to support.</p>	<p>Use known bonds and knowledge of place value to add multiples of 10</p>

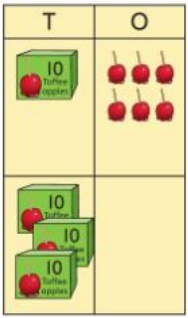
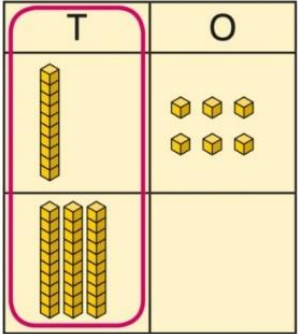
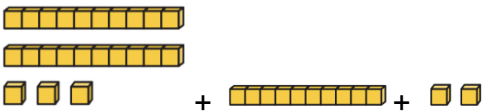
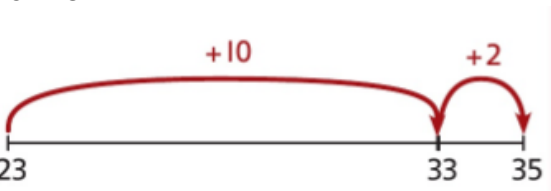
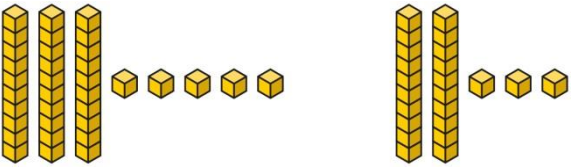
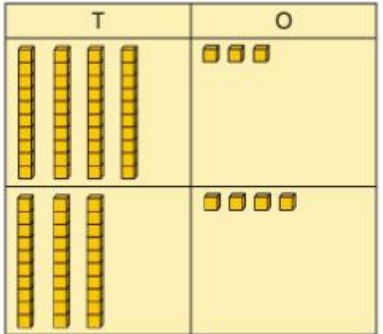

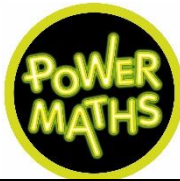
	 <p>16 is 1 ten and 6 ones. 30 is 3 tens. There are 4 tens and 6 ones in total.</p>	 <p>16 is 1 ten and 6 ones. 30 is 3 tens. There are 4 tens and 6 ones in total.</p>	<p><math>16 + 30 = ?</math></p> <p>1 ten + 3 tens is 4 tens</p> <p>There are 4 tens and 6 ones in total.</p> <p><math>16 + 30 = 46</math></p> <p>Count on in tens from a given number</p> <p>'Start on 16', '26', '36', '46'</p> <p><math>16 + 30 = 46</math></p>
<p><b>Add more 10s then more 1s</b></p>	<p>Add on from a 2-digit number by adding tens then ones.</p>  <p>Start on "23", "33", "35"</p>	<p>Add on from a 2-digit number by adding 10s then 1s.</p>  <p><math>23 + 12 = 23 + 10 + 2</math></p>	<p>Add on from a 2-digit number by adding tens then ones.</p> <p><math>23 + 12 = 23 + 10 + 2</math></p>
<p><b>Add the 1s and 10s separately</b></p>	<p>Add the 10s and 1s separately.</p>  <p><math>5 + 3 = 8</math> There are 8 ones in total.</p> <p><math>3 + 2 = 5</math></p>	<p>Add the 1s and the 10s then recombine</p> 	<p>Add the 10s and 1s separately.</p> <p><math>32 + 11</math></p> <p><math>30 + 10 = 40</math>      <math>2 + 1 = 3</math></p> <p><math>32 + 11 = 43</math></p>

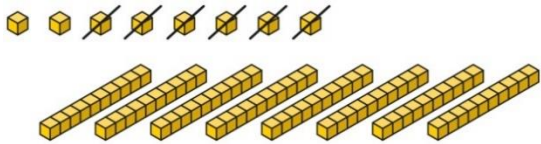
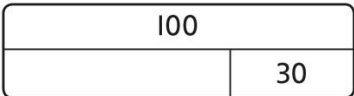
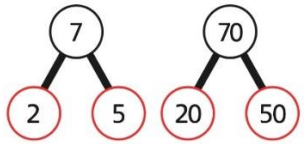
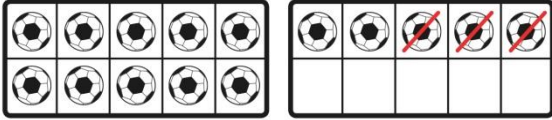

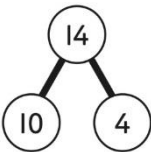
	<p><i>There are 5 tens in total.</i></p> $35 + 23 = 58$	<p>3 ones and 4 ones is 7 ones</p> <p>4 tens and 3 tens is 7 tens</p> $43 + 34 = 77$	
<b>Year 2 Subtraction</b>			
<b>Subtract two multiples of 10</b>	<p>Use known number bonds and unitising to subtract multiples of 10.</p>  <p><i>8 subtract 6 is 2. So, 8 tens subtract 6 tens is 2 tens.</i></p>	<p>Use known number bonds and unitising to subtract multiples of 10.</p>  <p><math>10 - 3 = 7</math> <i>So, 10 tens subtract 3 tens is 7 tens.</i></p>	<p>Use known number bonds and unitising to subtract multiples of 10.</p>  <p><i>7 tens subtract 5 tens is 2 tens.</i> <math>70 - 50 = 20</math></p>
<b>Subtraction within 20</b>	<p><b>Subtraction within 20</b> Understand when and how to subtract 1s efficiently.</p>  <p><math>5 - 3 = 2</math> <math>15 - 3 = 12</math></p>	<p><b>Subtraction within 20</b> Understand how to use knowledge of bonds within 10 to subtract efficiently.</p> <p><math>5 - 3 = 2</math> <math>15 - 3 = 12</math></p>	<p><b>Subtraction within 20</b> Understand when and how to subtract 1s efficiently.</p> <p>Use a bead string to subtract 1s efficiently.</p>  <p><math>5 - 3 = 2</math> <math>15 - 3 = 12</math></p>
<b>Subtracting 10s and 1s</b>	<p><b>Subtracting 10s and 1s</b> For example: <math>18 - 12</math></p> <p>Use ten frames to represent the efficient method of subtracting 12.</p>	<p><b>Subtracting 10s and 1s</b> Use a part-whole model to support the calculation.</p> 	<p><b>Subtracting 10s and 1s</b> For example: <math>18 - 12</math></p> <p><i>First subtract the 10, then take away 2.</i></p>



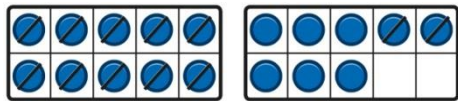
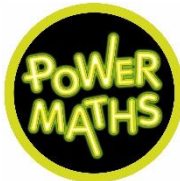

First subtract the 10, then subtract 2.

$$19 - 14$$

$$19 - 10 = 9$$

$$9 - 4 = 5$$

So,  $19 - 14 = 5$

**Subtraction bridging 10 using number bonds**

**Subtraction bridging 10 using number bonds**

Represent the use of bonds using ten frames.

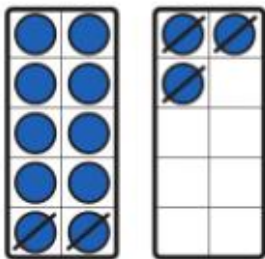

For  $13 - 5$ , I take away 3 to make 10, then take away 2 to make 8.

**Subtraction bridging 10 using number bonds**

Use a number line and a part-whole model to support the method.

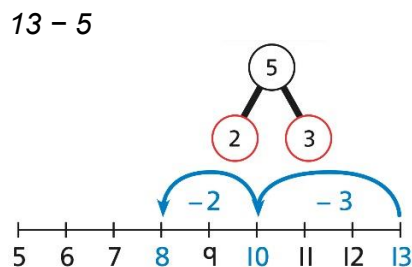

**Subtraction bridging 10 using number bonds**

For example:  $12 - 7$

Arrange objects into a 10 and some 1s, then decide on how to split the 7 into parts.

7 is 2 and 5, so I take away the 2 and then the 5.

**Subtracting a single-digit number**

Subtract the 1s. This may be done in or out of a place value grid using classroom items to represent the numbers.

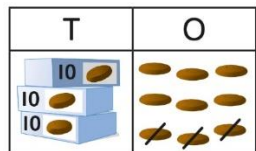
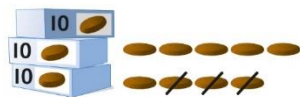

"9 ones subtract 3 ones is 6 ones"

$$39 - 3 = 36$$

Subtract the 1s. This may be done in or out of a place value grid.

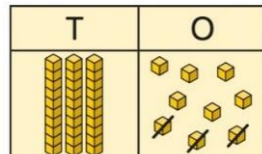
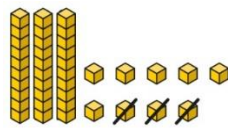

"9 ones subtract 3 ones is 6 ones"

$$39 - 3 = 36$$

Subtract the 1s. Understand the link between counting back and subtracting the 1s using known bonds.



$$9 - 3 = 6$$

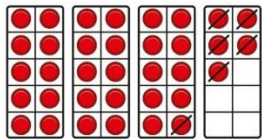
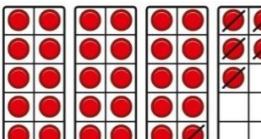
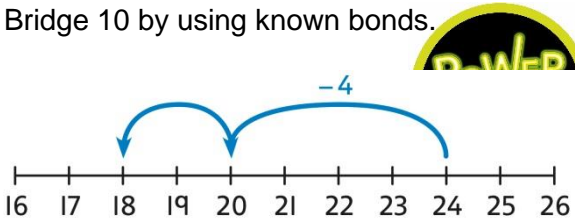
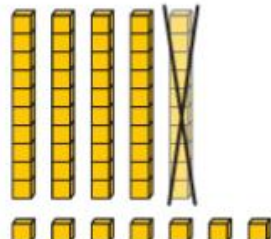
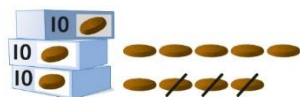
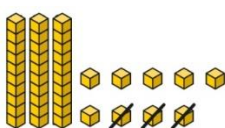
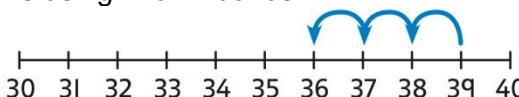

$$39 - 3 = 36$$



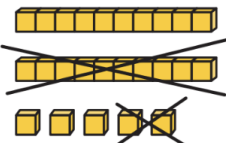
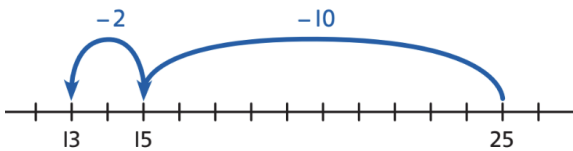
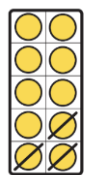
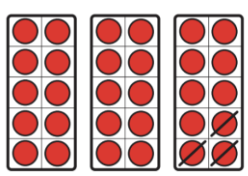
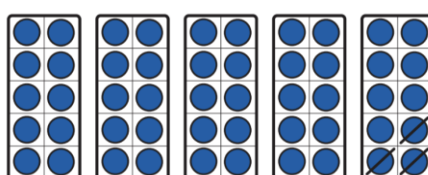
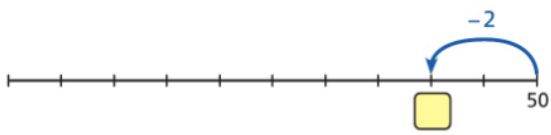

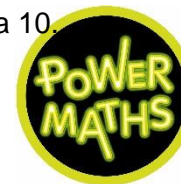
<p><b>Subtracting a single-digit number bridging 10</b></p>	<p>Bridge 10 by using known bonds.</p>  <p><math>35 - 6</math> I took away 5 counters, then 1 more.</p>	<p>Bridge 10 by using known bonds.</p>  <p><math>35 - 6</math> First, I will subtract 5, then 1.</p>	<p>Bridge 10 by using known bonds.</p>  <p><math>24 - 6 = ?</math> <math>24 - 4 - 2 = ?</math></p>								
<p><b>Subtract tens from a 2-digit number</b></p>		<p>Subtract tens using known bonds</p>  <p><math>57 - 10 = 47</math></p>	<p>Subtract tens using known bonds</p> <p><math>43 - 10 = 33</math></p>								
<p><b>Subtract ones from a 2-digit number</b></p>	<p>Subtract the 1s. This may be done in or out of a place value grid.</p>  <table border="1" data-bbox="353 1165 607 1316"> <thead> <tr> <th>T</th> <th>O</th> </tr> </thead> <tbody> <tr> <td></td> <td></td> </tr> </tbody> </table> <p>9 ones subtract 3 ones is 6 ones.</p>	T	O			<p>Subtract the 1s. This may be done in or out of a place value grid.</p>  <table border="1" data-bbox="958 1197 1218 1348"> <thead> <tr> <th>T</th> <th>O</th> </tr> </thead> <tbody> <tr> <td></td> <td></td> </tr> </tbody> </table> <p>9 ones subtract 3 ones is 6 ones.</p>	T	O			<p>Subtract the 1s. Understand the link between counting back and subtracting the 1s using known bonds.</p>  <p><math>9 - 3 = 6</math></p> <p><math>39 - 3 = 36</math></p>
T	O										
T	O										

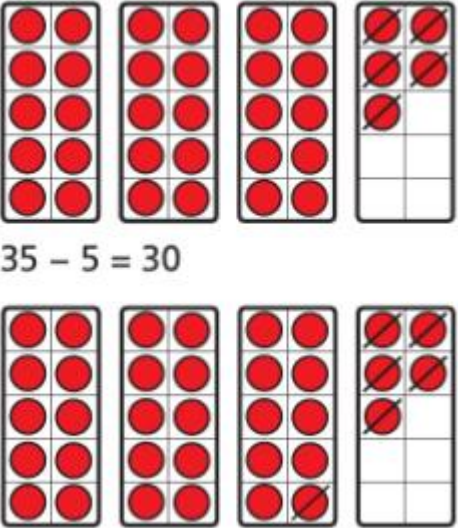
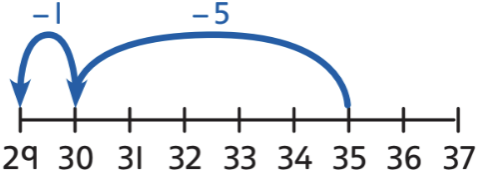

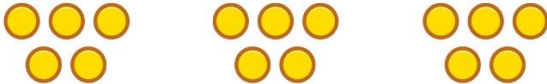
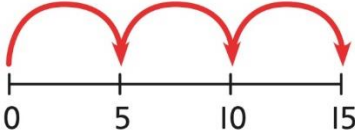
	$39 - 3 = 36$	$39 - 3 = 36$	
<p><b>Subtract tens and ones from a 2-digit number</b></p>	<p>Subtract 10s then 1s using place value equipment.</p>  <p><math>25 - 10 - 2 = 13</math></p> <p><math>25 - 12 = 13</math></p>	<p>Subtract 10s then 1s with a number line for visual support.</p>  <p><math>25 - 10 - 2 = 13</math></p> <p><math>25 - 12 = 13</math></p>	<p>Subtract 10s then 1s.</p> <p><math>25 - 10 - 2 = 13</math></p> <p><math>25 - 12 = 13</math></p>
<p><b>Subtract ones from a multiple of 10 (preparation for bridging)</b></p>	<p>Subtract from a 10 using known bonds to 10 using place value equipment.</p>  <p><math>10 - 3 = 7</math></p>  <p><math>30 - 3 = 27</math></p>  <p><math>50 - 3 = 47</math></p>	<p>Subtract from a 10 using known bonds to 10.</p>  <p><math>50 - 2 = 48</math></p>	<p>Subtract from a 10 using known bonds to 10.</p> <p><math>10 - 3 = 7</math></p> <p><math>30 - 3 = 27</math></p> <p><math>60 - 3 = 57</math></p> <p><math>90 - 3 = 87</math></p>

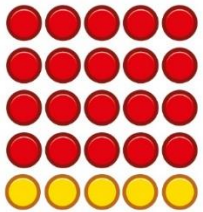
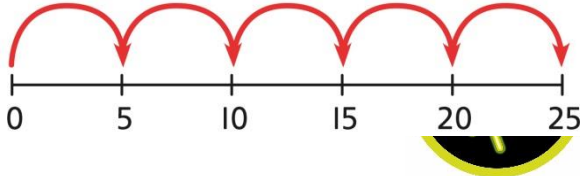

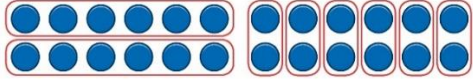
<p><b>Subtract bridging a ten</b></p>	<p>Subtract in two steps, across a 10 with place value equipment.</p>  <p><math>35 - 5 = 30</math></p>	<p>Subtract in two steps, across a 10 with a number line for visual support.</p>  <p><math>35 - 5 - 1 = 29</math></p>	<p>Subtract in two steps, across a 10.</p> <p><math>41 - 6 = 41 - 1 - 5</math></p> <p><math>41 - 6 = 35</math></p>
<p><b>Year 2 Multiplication</b></p>			
<p><b>Equal groups and repeated addition</b></p>	<p>Recognise equal groups and write as repeated addition and as multiplication.</p>  <p><i>3 groups of 5 chairs</i> <i>15 chairs altogether</i></p>	<p>Recognise equal groups using standard objects such as counters and write as repeated addition and multiplication.</p>  <p><i>3 groups of 5</i> <i>15 in total</i></p>	<p>Use a number line and write as repeated addition and as multiplication.</p>  <p><math>5 + 5 + 5 = 15</math> <math>3 \times 5 = 15</math></p>
<p><b>Using arrays to represent multiplication</b></p>	<p>Understand the relationship between arrays, multiplication and repeated addition.</p>	<p>Understand the relationship between arrays, multiplication and repeated addition.</p>	<p>Understand the relationship between arrays, multiplication and repeated addition.</p>

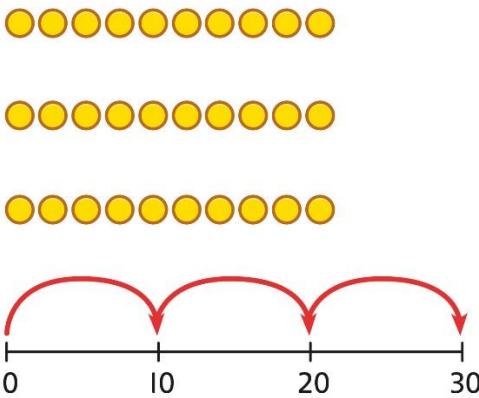
<p><b>and support understanding</b></p>	 <p>4 groups of 5</p>	 <p>4 groups of 5 ... 5 groups of 5</p>	 <p><math>5 \times 5 = 25</math></p>
<p><b>Understanding commutativity</b></p>	<p>Use arrays to visualise commutativity.</p>  <p>I can see 6 groups of 3. I can see 3 groups of 6.</p>	<p>Form arrays using counters to visualise commutativity. Rotate the array to show that orientation does not change the multiplication.</p>  <p>This is 2 groups of 6 and also 6 groups of 2.</p>	<p>Use arrays to visualise commutativity.</p>  <p><math>4 + 4 + 4 + 4 + 4 = 20</math> <math>5 + 5 + 5 + 5 = 20</math> <math>4 \times 5 = 20</math> and <math>5 \times 4 = 20</math></p>
<p><b>Learning <math>\times 2</math>, <math>\times 5</math> and <math>\times 10</math> table facts</b></p>	<p>Develop an understanding of how to unitise groups of 2, 5 and 10 and learn corresponding times-table facts.</p> 	<p>Understand how to relate counting in unitised groups and repeated addition with knowing key times-table facts.</p> 	<p>Understand how the times-tables increase and contain patterns.</p>







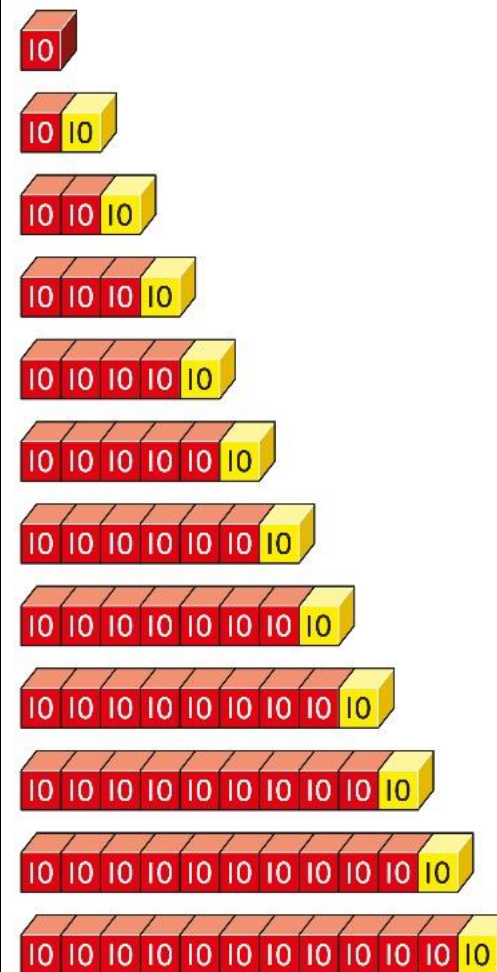

3 groups of 10 ... 10, 20, 30  
 $3 \times 10 = 30$

$10 + 10 + 10 = 30$   
 $3 \times 10 = 30$

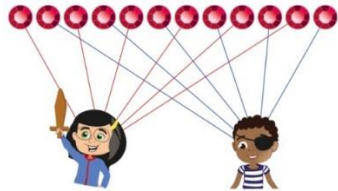



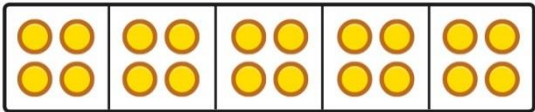
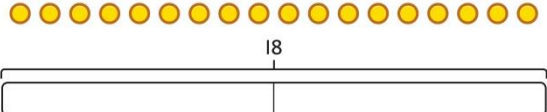



$5 \times 10 = 50$   
 $6 \times 10 = 60$

**Year 2  
 Division**

<p><b>Sharing equally</b></p>	<p>Start with a whole and share into equal parts, one at a time.</p>  <p>12 shared equally between 2. They get 6 each.</p> <p>Start to understand how this also relates to grouping. To share equally between 3 people, take a group of 3 and give 1 to each person. Keep going until all the objects have been shared</p>   <p>They get 5  each.</p> <p>15 shared equally between 3. They get 5 each.</p>	<p>Represent the objects shared into equal parts using a bar model.</p>  <p>20 shared into 5 equal parts. There are 4 in each part.</p>	<p>Use a bar model to support understanding of the division.</p>  <p>18 ÷ 2 = 9</p>
<p><b>Grouping equally</b></p>	<p>Understand how to make equal groups from a whole.</p> 	<p>Understand the relationship between grouping and the division statements.</p>	<p>Understand how to relate division by grouping to repeated subtraction.</p>

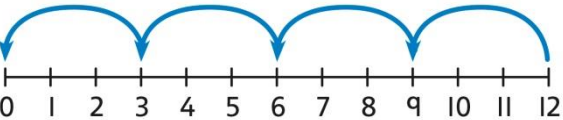
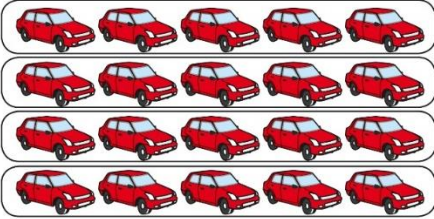

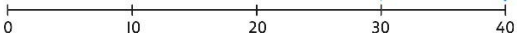
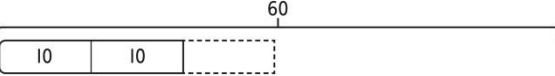
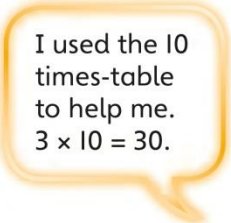
	<p>8 divided into 4 equal groups. There are 2 in each group.</p>	<p><math>12 \div 3 = 4</math>    <math>12 \div 4 = 3</math>    <math>12 \div 6 = 2</math>    <math>12 \div 2 = 6</math>  </p>	  <p>There are 4 groups now.</p> <p>12 divided into groups of 3. <math>12 \div 3 = 4</math></p> <p>There are 4 groups.</p>
<p><b>Using known times-tables to solve divisions</b></p>	<p>Understand the relationship between multiplication facts and division.</p>  <p>4 groups of 5 cars is 20 cars in total. 20 divided by 4 is 5.</p>	<p>Link equal grouping with repeated subtraction and known times-table facts to support division.</p>   <p>40 divided by 4 is 10.</p> <p>Use a bar model to support understanding of the link between times-table knowledge and division.</p> 	<p>Relate times-table knowledge directly to division.</p> <p><math>1 \times 10 = 10</math>  <math>2 \times 10 = 20</math>  <math>3 \times 10 = 30</math>  <math>4 \times 10 = 40</math>  <math>5 \times 10 = 50</math>  <math>6 \times 10 = 60</math>  <math>7 \times 10 = 70</math>  <math>8 \times 10 = 80</math></p>  <p>I know that 3 groups of 10 makes 30, so I know that 30 divided by 10 is 3.</p> <p><math>3 \times 10 = 30</math> so <math>30 \div 10 = 3</math></p>